

REVISIONS				
REV.	ECO. NO	DESCRIPTION	DATE	BY
A	1635	INITIAL RELEASE	3/14/2008	VJ

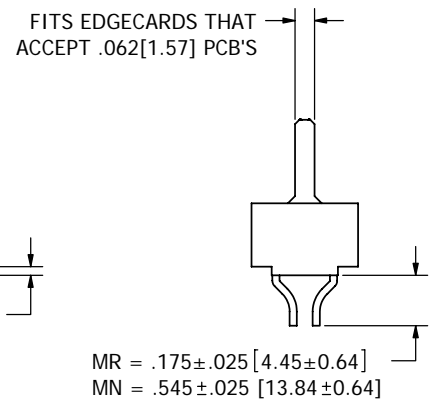
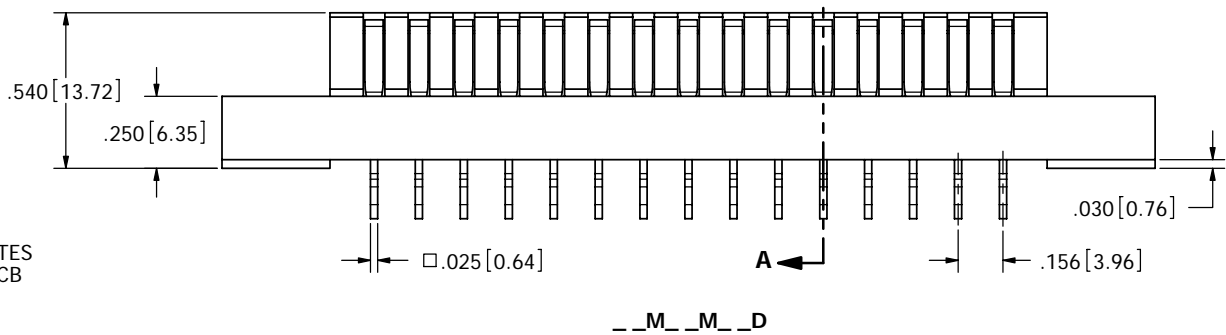
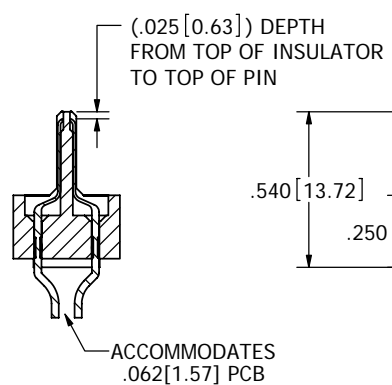
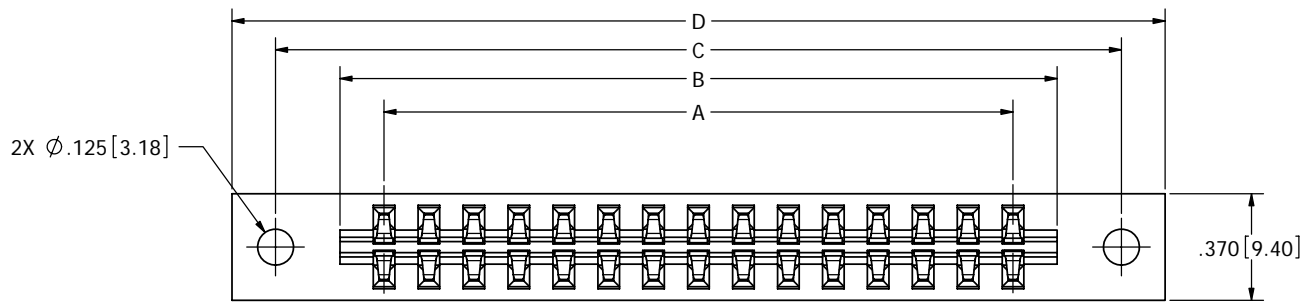

SECTION A-A

--M--M--D

- NOTES:
- INSULATOR MATERIAL: SEE PART NUMBER CODING.
 - CONTACT MATERIAL: SEE PART NUMBER CODING.
 - PLATING: SEE PART NUMBER CODING.
 - TEMPERATURE: SEE PART NUMBER CODING.
 - PROCESSING TEMP: SEE PART NUMBER CODING.
 - UL FLAMMABILITY RATING: 94V-0.
 - VOLTAGE RATING: 600 VDC MINIMUM AT SEA LEVEL.
 - CURRENT RATING: 3 AMP PER CONTACT.
 - VOLTAGE DROP: 30 MILLI VOLT AT RATED CURRENT.
 - INSULATION RESISTANCE: 5000 MEGA OHMS.
 - CONNECTOR IDENTIFICATION: THE PART SHALL BE MARKED WITH A PART NUMBER AND BARCODE.



RoHS COMPLIANT

CUSTOMER COPY

UNLESS OTHERWISE SPECIFIED: DIMENSIONS ARE IN INCHES[MM]		DATE	NAME	SULLINS ELECTRONICS DESCRIPTION MALE, CARD EXTENDER, .156 CC PART NUMBER --M--M--D (MR, MN)
TOLERANCES: ANGULAR: ± 1° XX = ± .02 [.508] .XXX = ± .005 [.1270] .XXXX = ± .0005 [.0127] PARENTHETICAL INFORMATION IS FOR REFERENCE ONLY		3/14/2008	V. JARA	
INTERPRET DIMENSIONS AND GEOMETRIC TOLERANCING PER: ANSI Y14.5-1984		SIZE	DWG. NO	REV
		C	C11074	A
		SCALE: 3:1	SHEET 1 OF 3	

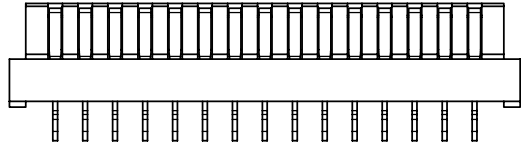
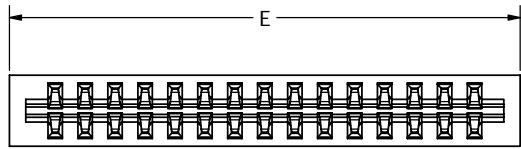

--M_M_N

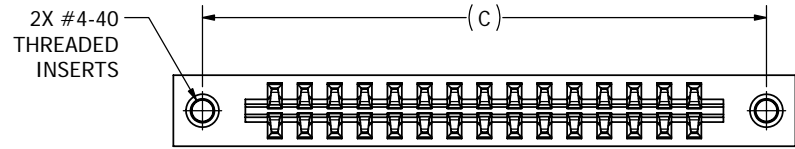

2X #4-40
THREADED
INSERTS

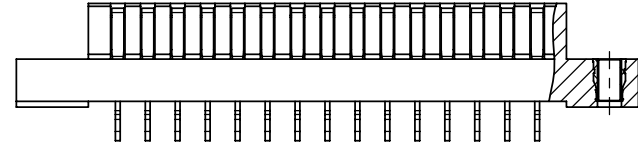

--M_M_T

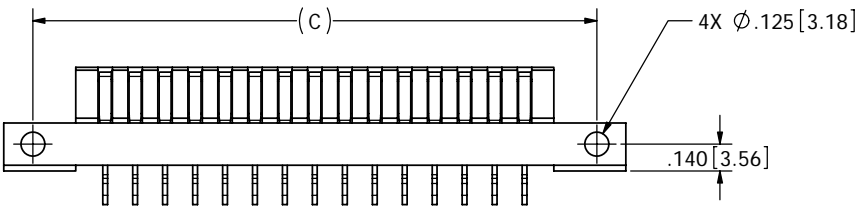
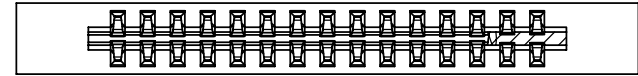
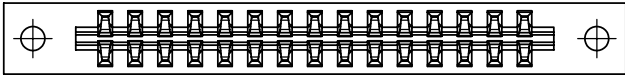

--M_M_Z

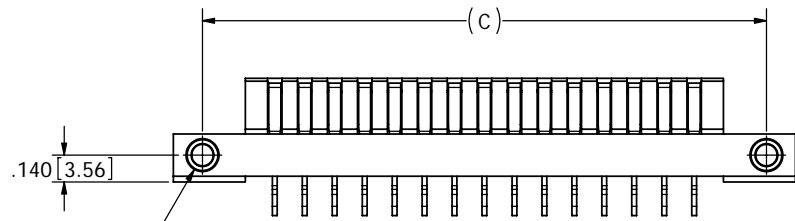

--M_M_V

2X #4-40
THREADED
INSERTS

CUSTOMER COPY



RoHS COMPLIANT

UNLESS OTHERWISE SPECIFIED: DIMENSIONS ARE IN INCHES[MM]		DATE		NAME	
TOLERANCES:		3/14/2008		V. JARA	
ANGULAR: ± 1°		THE INFORMATION HEREIN CONTAINS PROPRIETARY INFORMATION OF SULLINS ELECTRONICS AND IS NOT TO BE REPRODUCED, USED OR DISCLOSED TO OTHERS FOR ANY PURPOSE EXCEPT AS SPECIFICALLY AUTHORIZED IN WRITING BY AN OFFICER OF SULLINS ELECTRONICS.			
XX = ± .02 [.508]		DESCRIPTION			
.XXX = ± .005 [.1270]		MALE, CARD EXTENDER, .156 CC			
.XXXX = ± .0005 [.0127]		PART NUMBER			
PARENTHEetical INFORMATION IS FOR REFERENCE ONLY		--M_M_-- (MR, MN)			
INTERPRET DIMENSIONS AND GEOMETRIC TOLERANCING PER: ANSI Y14.5-1984		SIZE	DWG. NO.	REV	
		C	C11074	A	
		SCALE: 2:1		SHEET 2 OF 3	

PART NUMBER	NO. OF POS.	A ±.008[0.20]		B ±.008[0.20]		C ±.010[0.25]		D ±.020[0.51]		*E ±.020[0.51]	
		IN	MM	IN	MM	IN	MM	IN	MM	IN	MM
M04M	4	0.468	11.89	0.774	19.66	1.221	31.01	1.524	38.71	0.944	23.98
M05M	5	0.624	15.85	0.930	23.62	1.377	34.98	1.680	42.67	1.100	27.94
M06M	6	0.780	19.81	1.086	27.58	1.533	38.94	1.836	46.63	1.256	31.90
M07M	7	0.936	23.77	1.242	31.55	1.689	42.90	1.992	50.60	1.412	35.86
M08M	8	1.092	27.74	1.398	35.51	1.845	46.86	2.148	54.56	1.568	39.83
M09M	9	1.248	31.70	1.554	39.47	2.001	50.83	2.304	58.52	1.724	43.79
M10M	10	1.404	35.66	1.710	43.43	2.157	54.79	2.460	62.48	1.880	47.75
M11M	11	1.560	39.62	1.866	47.40	2.313	58.75	2.616	66.45	2.036	51.71
M12M	12	1.716	43.59	2.022	51.36	2.469	62.71	2.772	70.41	2.192	55.68
M13M	13	1.872	47.55	2.178	55.32	2.625	66.68	2.928	74.37	2.348	59.64
M14M	14	2.028	51.51	2.334	59.28	2.781	70.64	3.084	78.33	2.504	63.60
M15M	15	2.184	55.47	2.490	63.25	2.937	74.60	3.240	82.30	2.660	67.56
M16M	16	2.340	59.44	2.646	67.21	3.093	78.56	3.396	86.26	2.816	71.53
M17M	17	2.496	63.40	2.802	71.17	3.249	82.52	3.552	90.22	2.972	75.49
M18M	18	2.652	67.36	2.958	75.13	3.405	86.49	3.708	94.18	3.128	79.45
M19M	19	2.808	71.32	3.114	79.10	3.561	90.45	3.864	98.15	3.284	83.41
M20M	20	2.964	75.29	3.270	83.06	3.717	94.41	4.020	102.11	3.440	87.38
M21M	21	3.120	79.25	3.426	87.02	3.873	98.37	4.176	106.07	3.596	91.34
M22M	22	3.276	83.21	3.582	90.98	4.029	102.34	4.332	110.03	3.752	95.30
M23M	23	3.432	87.17	3.738	94.95	4.185	106.30	4.488	114.00	3.908	99.26
M24M	24	3.588	91.14	3.894	98.91	4.341	110.26	4.644	117.96	4.064	103.23
M25M	25	3.744	95.10	4.050	102.87	4.497	114.22	4.800	121.92	4.220	107.19
M26M	26	3.900	99.06	4.206	106.83	4.653	118.19	4.956	125.88	4.376	111.15
M27M	27	4.056	103.02	4.362	110.79	4.809	122.15	5.112	129.84	4.532	115.11
M28M	28	4.212	106.98	4.518	114.76	4.965	126.11	5.268	133.81	4.688	119.08
M29M	29	4.368	110.95	4.674	118.72	5.121	130.07	5.424	137.77	4.844	123.04
M30M	30	4.524	114.91	4.830	122.68	5.277	134.04	5.580	141.73	5.000	127.00
M31M	31	4.680	118.87	4.986	126.64	5.433	138.00	5.736	145.69	5.156	130.96
M32M	32	4.836	122.83	5.142	130.61	5.589	141.96	5.892	149.66	5.312	134.92
M33M	33	4.992	126.80	5.298	134.57	5.745	145.92	6.048	153.62	5.468	138.89
M34M	34	5.148	130.76	5.454	138.53	5.901	149.89	6.204	157.58	5.624	142.85
M35M	35	5.304	134.72	5.610	142.49	6.057	153.85	6.360	161.54	5.780	146.81
M36M	36	5.460	138.68	5.766	146.46	6.213	157.81	6.516	165.51	5.936	150.77
M37M*	37	5.616	142.65	5.922	150.42					6.092	154.74
M38M*	38	5.772	146.61	6.078	154.38					6.248	158.70
M39M*	39	5.928	150.57	6.234	158.34					6.404	162.66
M40M*	40	6.084	154.53	6.390	162.31					6.560	166.62

*'N' MTG ONLY

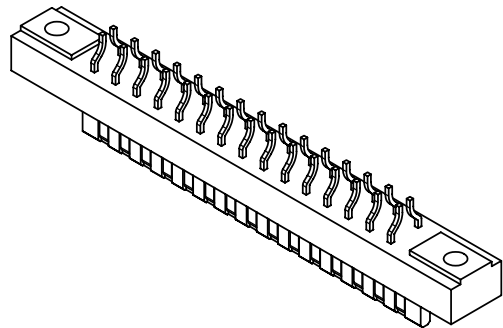
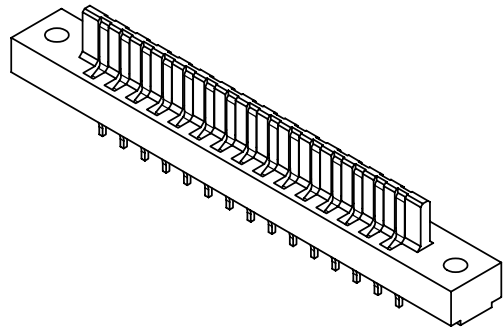

PART NUMBER CODING

-- M -- M --

MATERIAL (INSULATOR/CONTACT)

E = PBT/PHOSPHOR BRONZE
 OPERATING TEMP: -65°C TO +125°C
 PROCESSING TEMP: 260°C FOR 10 SECS MAX

G = PA9T/PHOSPHOR BRONZE
 OPERATING TEMP: -65°C TO +125°C
 PROCESSING TEMP: 260°C FOR 120 SECS MAX
 (CONSULT FACTORY FOR OTHER MATERIALS)

PLATING

ALL PLATINGS ARE LEAD FREE AND HAVE .000050" NICKEL UNDERPLATE

CONTACT SURFACE	TERMINATION
B = .000010" GOLD	.000100" PURE TIN, MATTE
C = .000030" GOLD	.000100" PURE TIN, MATTE
Y = .000030" GOLD	.000005" GOLD

MOUNTING STYLE

D = FLUSH .125" DIA. CLEARANCE HOLES (PAGE 1)
 N = NO MOUNTING EARS (PAGE 2)
 Z = FLUSH .125" DIA. SIDE MOUNTING (PAGE 2)
 T = FLUSH, #4-40 THREADED INSERT (PAGE 2)
 V = FLUSH, SIDE MOUNT #4-40 THREADED INSERT (PAGE 2)

TERMINATION

MR = CARD EXTENDER, .175[4.45] TAIL LENGTH
 MN = CARD EXTENDER, .545[13.84] TAIL LENGTH

NUMBER OF POSITIONS (CONTACTS PER ROW)



RoHS COMPLIANT

CUSTOMER COPY

UNLESS OTHERWISE SPECIFIED: DIMENSIONS ARE IN INCHES[MM]		DATE	NAME	SULLINS ELECTRONICS DESCRIPTION MALE, CARD EXTENDER, .156 CC PART NUMBER -- M -- M -- (MR, MN)
TOLERANCES: ANGULAR: ± 1° XX = ± .02 [.508] .XXX = ± .005 [.1270] .XXXX = ± .0005 [.0127] PARENTHETICAL INFORMATION IS FOR REFERENCE ONLY		3/14/2008	V. JARA	
THE INFORMATION HEREIN CONTAINS PROPRIETARY INFORMATION OF SULLINS ELECTRONICS AND IS NOT TO BE REPRODUCED, USED OR DISCLOSED TO OTHERS FOR ANY PURPOSE EXCEPT AS SPECIFICALLY AUTHORIZED IN WRITING BY AN OFFICER OF SULLINS ELECTRONICS.		SIZE	DWG. NO.	REV
INTERPRET DIMENSIONS AND GEOMETRIC TOLERANCING PER: ANSI Y14.5-1984		C	C11074	A
SCALE: 2:1		SHEET 3 OF 3		